





Door Hardware

Please call for the **Best Price**
(954) 825-4731

HINGES

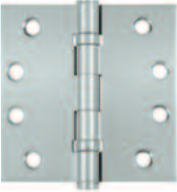
	Item No.	Description	Box QTY	LIST
	06805	3-1/2x3-1/2 5/8-Radius Primed-Finish	100	1.10
	06795	3-1/2x3-1/2 5/8-Radius 2D-Finish	100	1.70
	US2D 06789	3-1/2x3-1/2 5/8-Radius 15-Finish	100	1.75
	06790	3-1/2x3-1/2 5/8-Radius 15A-Finish	100	2.10
	06799	3-1/2x3-1/2 5/8-Radius 5-Finish	100	2.20
	06793	3-1/2x3-1/2 5/8-Radius 26-Finish	100	5.80
	53257	3-1/2x3-1/2 5/8-Radius 10C-Finish	100	6.10
	US10C 89550	3-1/2x3-1/2 5/8-Radius Ball-Bearing 10C-Finish	100	3.20
	06801	3-1/2x3-1/2 5/8-Radius Ball-Bearing 15-Finish	100	2.75
	06802	3-1/2x3-1/2 5/8-Radius Ball-Bearing 15A-Finish	100	3.20
	24322	3-1/2x3-1/2 5/8-Radius Ball-Bearing 26-Finish	100	7.15
	24323	3-1/2x3-1/2 5/8-Radius Ball-Bearing 5-Finish	100	7.15
	US15 96867	LH 4x4 5/8-Radius/Square Spring 15-Finish	50	10.40
	96868	RH 4x4 5/8-Radius/Square Spring 15-Finish	50	10.40
	79099	LH 4x4 5/8-Radius/Square Spring Primed-Finish	50	11.60
	79100	RH 4x4 5/8-Radius/Square Spring Primed-Finish	50	11.60
	08098	LH 4x4 5/8-Radius/Square Spring 2D-Finish	50	11.90
	08099	RH 4x4 5/8-Radius/Square Spring 2D-Finish	50	11.90
	96865	LH 4x4 5/8-Radius/Square Spring 10C-Finish	50	12.40
	96866	RH 4x4 5/8-Radius/Square Spring 10C-Finish	50	12.40
	US26 96863	LH 4x4 5/8-Radius/Square Spring 5-Finish	50	12.40
	96864	RH 4x4 5/8-Radius/Square Spring 5-Finish	50	12.40
	96869	LH 4x4 5/8-Radius/Square Spring 15A-Finish	50	12.40
	96870	RH 4x4 5/8-Radius/Square Spring 15A-Finish	50	12.40
	96871	LH 4x4 5/8-Radius/Square Spring 26-Finish	50	12.40
	96872	RH 4x4 5/8-Radius/Square Spring 26-Finish	50	12.40
	Primed 08107	LH 4x4 5/8-Radius/Square Safety Stud 2D-Finish	100	1.76
	08114	RH 4x4 5/8-Radius/Square Safety Stud 2D-Finish	100	1.96
	08109	LH 4x4 5/8-Radius/Square Safety Stud Primed-	5000	2.00
	08116	RH 4x4 5/8-Radius/Square Safety Stud Primedb	5000	2.00
	08104	LH 4x4 5/8-Radius/Square Safety Stud 15A-Finish	100	2.40
	08111	RH 4x4 5/8-Radius/Square Safety Stud 15A-Finish	100	2.40

Sold In Full Carton Only.



Square



5/8-Radius



www.JELD-WENEXPORT.COM

Door Hardware

HINGES

Item No.	Description	Box QTY	LIST
08103	LH 4x4 5/8-Radius/Square Safety Stud 15-Finish	100	2.30
08110	RH 4x4 5/8-Radius/Square Safety Stud 15-Finish	100	2.30
08105	LH 4x4 5/8-Radius/Square Safety Stud 26-Finish	100	2.80
08112	RH 4x4 5/8-Radius/Square Safety Stud 26-Finish	100	2.80
27829	LH 4x4 5/8-Radius/Square Safety Stud 5-Finish	100	2.95
27830	RH 4x4 5/8-Radius/Square Safety Stud 5-Finish	100	2.95
89571	LH 4x4 5/8-Radius/Square Safety Stud 10C-Finish	100	3.15
89572	RH 4x4 5/8-Radius/Square Safety Stud 10C-Finish	100	3.15
A4150	LH 4x4 5/8-Radius/Square Safety Stud Ball-Bearing Primed-Finish	100	3.40
A4151	RH 4x4 5/8-Radius/Square Safety Stud Ball-Bearing Primed-Finish	100	3.40
96842	LH 4x4 5/8-Radius/Square Safety Stud Ball Bearing 2D-Finish	100	3.20
96843	RH 4x4 5/8-Radius/Square Safety Stud Ball Bearing 2D-Finish	100	3.20
96848	LH 4x4 5/8-Radius/Square Safety Stud Ball Bearing 10C-Finish	100	4.15
96849	RH 4x4 5/8-Radius/Square Safety Stud Ball Bearing 10C-Finish	100	4.15
96846	LH 4x4 5/8-Radius/Square Safety Stud Ball-Bearing 5-Finish	100	3.95
96847	RH 4x4 5/8-Radius/Square Safety Stud Ball-Bearing 5-Finish	100	3.95
96850	LH 4x4 5/8-Radius/Square Safety Stud Ball Bearing 15-Finish	100	3.30
96851	RH 4x4 5/8-Radius/Square Safety Stud Ball Bearing 15-Finish	100	3.30
96852	LH 4x4 5/8-Radius/Square Safety Stud Ball-Bearing 15A-Finish	100	3.95
96853	RH 4x4 5/8-Radius/Square Safety Stud Ball-Bearing 15A-Finish	100	3.95
96854	LH 4x4 5/8-Radius/Square Safety Stud Ball-Bearing 26-Finish	100	4.30
96855	RH 4x4 5/8-Radius/Square Safety Stud Ball-Bearing 26-Finish	100	4.30
96858	LH 4x4 5/8-Radius/Square Safety Stud Ball-Bearing 32D-Finish	100	20.40
96859	RH 4x4 5/8-Radius/Square Safety Stud Ball-Bearing 32D-Finish	100	20.40



Primed



US2D

Sold In Full Carton Only.

Door Hardware

HINGES

Item No.	Description	Box QTY	LIST
A9745	4x4 5/8-Radius Safety Stud Ball Bearing 2D-Finish	100	3.20
A9748	4x4 5/8-Radius Safety Stud Ball Bearing 15-Finish	100	3.30
A9752	4x4 5/8-Radius Safety Stud Ball Bearing Primed-Finish	100	3.40
A9746	4x4 5/8-Radius Safety Stud Ball Bearing 5-Finish	100	3.95
A9749	4x4 5/8-Radius Safety Stud Ball Bearing 15A-Finish	100	3.95
A9747	4x4 5/8-Radius Safety Stud Ball Bearing 10C-Finish	100	4.15
A9750	4x4 5/8-Radius Safety Stud Ball Bearing 26-Finish	100	4.30
A9751	4x4 5/8-Radius Safety Stud Ball Bearing 32D-Finish	100	20.40
A1366	LH 4x4-1/4 5/8-Radius/Square Safety Stud Ball Bearing 15-Finish	100	3.40
A1367	RH 4x4-1/4 5/8-Radius/Square Safety Stud Ball Bearing 15-Finish	100	3.40
A4288	LH 4x4-1/4 5/8-Radius/Square Safety Stud Ball Bearing 2D-Finish	100	3.40
A4289	RH 4x4-1/4 5/8-Radius/Square Safety Stud Ball Bearing 2D-Finish	100	3.40
A4286	LH 4x4-1/4 5/8-Radius/Square Safety Stud Ball-Bearing Primed-Finish	100	3.60
A4287	RH 4x4-1/4 5/8-Radius/Square Safety Stud Ball-Bearing Primed-Finish	100	3.60
A1372	LH 4x4-1/4 5/8-Radius/Square Safety Stud Ball Bearing 10C-Finish	100	3.95
A1373	RH 4x4-1/4 5/8-Radius/Square Safety Stud Ball Bearing 10C-Finish	100	3.95
A1370	LH 4x4-1/4 5/8-Radius/Square Safety Stud Ball Bearing 5-Finish	100	3.95
A1371	RH 4x4-1/4 5/8-Radius/Square Safety Stud Ball Bearing 5-Finish	100	3.95
A1374	LH 4x4-1/4 5/8-Radius/Square Safety Stud Ball Bearing 15A-Finish	100	3.95
A1375	RH 4x4-1/4 5/8-Radius/Square Safety Stud Ball Bearing 15A-Finish	100	3.95
A1376	LH 4x4-1/4 5/8-Radius/Square Safety Stud Ball Bearing 26-Finish	100	3.95
A1377	RH 4x4-1/4 5/8-Radius/Square Safety Stud Ball Bearing 26-Finish	100	3.95
B8627	LH 4x4-1/4 5/8-Radius/Square Safety Stud Ball Bearing 32D-Finish	100	22.00
B8628	RH 4x4-1/4 5/8-Radius/Square Safety Stud Ball Bearing 32D-Finish	100	22.00
A1364	LH 4x4-1/4 5/8-Radius/Square Safety Stud 15-Finish	100	2.40
A1365	RH 4x4-1/4 5/8-Radius/Square Safety Stud 15-Finish	100	2.40
A4284	LH 4x4-1/4 5/8-Radius/Square Safety Stud Primed-Finish	100	2.60
A4285	RH 4x4-1/4 5/8-Radius/Square Safety Stud Primed-Finish	100	2.60

Sold In Full Carton Only.

Door Hardware

Barn Door Hardware



PAGE 84

Barn Door Hardware

CAT. NO.	DESCRIPTION
0T4812	N186-960 Interior sliding door hardware 72" Oil Rubbed Bronze.
0T4817	N187-001 sliding door hardware connecting adaptor Oil Rubbed Bronze.
0T4824	N186-962 Interior sliding door hardware 72" Stainless Steel.
0T4825	N187-002 Sliding door hardware connecting adaptor Stainless Steel



Barn Door Hardware
shown in Oil Rubbed Bronze

Door Hardware

JOHNSON POCKET		
CAT. NO.	DESCRIPTION	LIST
13767	Johnson# 1500 3/0 x 6/8 Wallpocket Frame 2/0-3/0 Adjustable. Great when space is an issue.	133.25

CUSTOM FRAMES
AVAILABLE

CALL FOR AVAILABILITY

Wall Mount	
CAT. NO.	DESCRIPTION
78611	Johnson 2610F721 Wallpocket Hardware Set



BIFOLD HARDWARE for Louver Bifolds		
CAT. NO.	DESCRIPTION	Retail
16540	2/0 Track White	2.50
16541	2/6 Track White	3.75
16542	3/0 Track White	4.55
16543	4/0 Track White	6.05
16544	5/0 Track White	7.60
16545	6/0 Track White	8.30
54050	2-door bag of hardware	7.75

BIFOLD HARDWARE For Moulded & Birch Bifolds		
CAT. NO.	DESCRIPTION	Retail
16564	2/0 White Track	3.95
16566	2/6 White Track	3.95
16568	3/0 White Track	3.95
16569	4/0 White Track	4.80
16571	5/0 White Track	5.70
16572	6/0 White Track	6.60
16561	2-door bag of hardware	6.50

Door Hardware

HEAVY DUTY ARCHITECTURAL DOOR HARDWARE

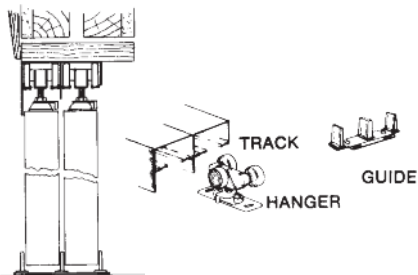

CAT. NO.	DESCRIPTION	PACK	Retail
----------	-------------	------	--------

#138F Sliding Door Hardware Heavy Duty for 1-3/8" Doors

13763	48" Track & Hardware	5	53.15
13764	60" Track & Hardware	5	59.75
13765	72" Track & Hardware	5	66.10
13766	96" Track & Hardware	5	103.55

#134 Sliding Door Hardware Heavy Duty for 1-3/4" Doors

13759	48" Track & Hardware	5	56.70
13760	60" Track & Hardware	5	64.10
13761	72" Track & Hardware	5	71.20
13762	96" Track & Hardware	5	110.65

#100 Bifold Door Hardware Heavy Duty for 2-Door Units

13740	36" Track & Hardware	5	41.40
-------	----------------------	---	-------

#100 Bifold Door Hardware Heavy Duty for 4-Door Units

13741	48" Track & Hardware	5	70.55
13742	60" Track & Hardware	5	73.25
13743	72" Track & Hardware	5	76.70
13744	96" Track & Hardware	5	84.55

72461	Johnson #2054 Multi Pull Catch Set		11.55
-------	------------------------------------	--	-------

32980	703BC Door Closer		60.00
-------	-------------------	--	-------

10178	US3 Mortise in Ball Catch/Strike Plate		8.70
-------	--	--	------

10175	US3 Set Ball Catch		1.20
-------	--------------------	--	------

10734	Strikeplate US5		1.50
-------	-----------------	--	------

84275	Strikeplate US10B		1.50
-------	-------------------	--	------

10729	Strikeplate US15A		1.50
-------	-------------------	--	------

SLIDING DOOR HARDWARE

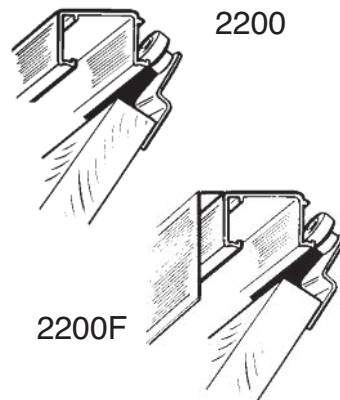

CAT. NO.	DESCRIPTION	PACK	Retail
----------	-------------	------	--------

#2200 HDWE

13824	48" Set/2 2/0 Doors	5	17.65
13825	60" Set/2 2/6 Doors	5	20.15
13826	72" Set/2 3/0 Doors	5	22.75
13827	96" Set/4 2/0 Doors	5	40.20

#2200F HDWE

13828	48" Set/2 2/0 Doors	5	26.40
13829	60" Set/2 2/6 Doors	5	30.10
13830	72" Set/2 3/0 Doors	5	33.95
13831	96" Set/4 2/0 Doors	5	56.30

#1825 BB/F HDWE

13813	3/0 2-Bifold Hdwe.	5	12.40
13814	4/0 4-Bifold Hdwe.	5	20.90
13815	5/0 4-Bifold Hdwe.	5	21.80
13816	6/0 4-Bifold Hdwe.	5	22.60
13817	8/0 4-Bifold Hdwe.	5	24.65

#1601 FOLDING DOOR HDWE.

13787	100% Access Hdwe.	5	21.80
-------	-------------------	---	-------

55499	1-3/8 Bypass Floor Guides #2138 Vinyl		2.52
-------	---------------------------------------	--	------

48768	1-3/8 Bypass Floor Guides #213500		2.52
-------	-----------------------------------	--	------

55498	1-3/4 Bypass Floor Guides #2134		2.52
-------	---------------------------------	--	------