

Door Hardware

Please call for the **Best Price**
(954) 825-4731

Knobs



Cove Privacy
Venetian Bronze



Cove Privacy
Satin Nickel



Cove Entry
Venetian Bronze



Cove Entry
Satin Nickel

Levers



Balboa Privacy
Venetian Bronze



Balboa Privacy
Satin Nickel



Balboa Entry
Venetian Bronze



Balboa Entry
Satin Nickel



Ladera Privacy
Venetian Bronze

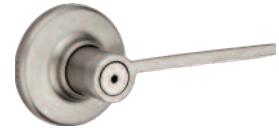

Ladera Privacy
Satin Nickel



Ladera Entry
Venetian Bronze



Ladera Entry
Satin Nickel

Available Finishes

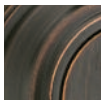

11P
Venetian
Bronze

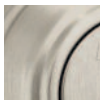

15
Satin
Nickel



FINISH AND
LIFETIME
WARRANTY
MECHANICAL
ONE YEAR
ELECTRONIC WARRANTY

JELD-WEN
WINDOWS & DOORS

JELD-WEN
WINDOWS & DOORS

www.JELD-WENEXPORT.COM



Deadbolts



Single Cylinder 660
Venetian Bronze



Single Cylinder 660
Satin Nickel



Double Cylinder 665
Venetian Bronze



Double Cylinder 665
Satin Nickel

Combo Packs



690P-660 Deadbolt
with Polo Entry knob
Venetian Bronze



690P-660 Deadbolt
with Polo Entry knob
Satin Nickel

Kwikset

Handlesets



Chelsea
Venetian Bronze



Chelsea
Satin Nickel



San Clemente
Venetian Bronze



San Clemente
Satin Nickel

Electronics



Kevo 2nd Gen
Venetian Bronze



Kevo 2nd Gen
Satin Nickel



SmartCode 909
Contemporary
Venetian Bronze



SmartCode 909
Contemporary
Satin Nickel

FLUSH BOLTS



4"

4FBS10B 14.⁰⁰



4FBS15 14.⁰⁰



6"

6FBR10B 19.⁸⁰



6FBR15 19.⁸⁰

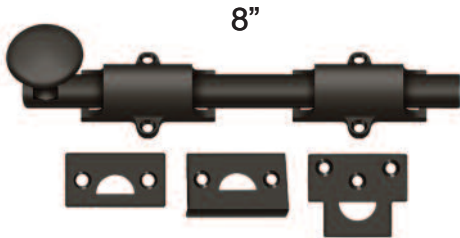

8"

8SB10B 51.⁶⁰

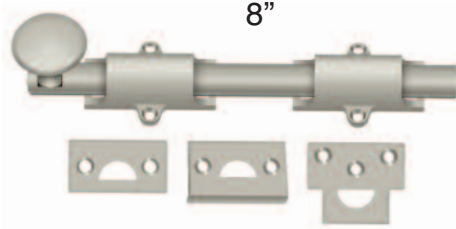

8"

8SB15 51.⁶⁰

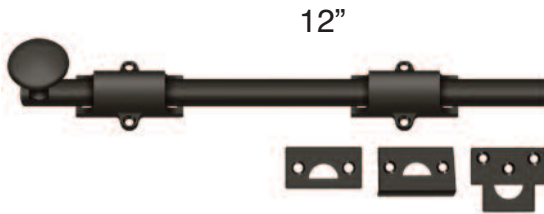

12"

12SB10B 62.⁴⁰

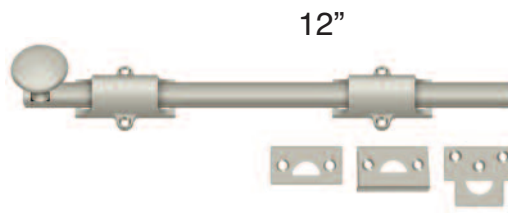

12"

12SB15 62.⁴⁰

BALL CATCHES



BC21BU10B 13.⁸



BC21BU15 13.⁸⁰



BTC10U10B 7.⁴⁰

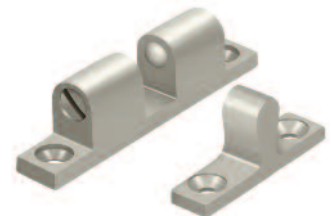

BTC10U15 7.⁴⁰

Door Hardware

Please call for the **Best Price**
(954) 825-4731

HINGES



S35R510B 10.⁶⁰



S35R515 10.⁶⁰



S44U10B-R 12.⁰⁰

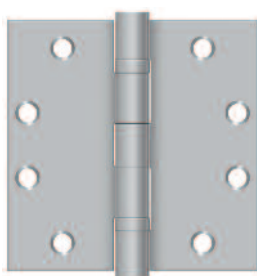

S45BBU26D 27.⁸⁰

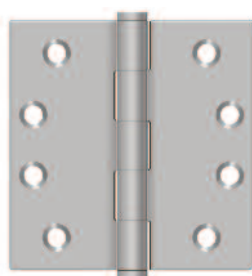

SS44U32D-R 27.⁸⁰

DOOR CLOSURE

POCKET LOCKS



DC50ALUM 71.⁰⁰



SDL25U10B 19.⁴⁰



SDL25U15 19.⁴⁰

Door Hardware

Please call for the **Best Price**
(954) 825-4731

BAR PULLS



BP3750SS 9.70

SHELL HANDLE PULLS



K407U10B 20.00



K407U15 20.00

FLUSH PULLS



FP7178U10B 34.40



FP7178U15 34.40



FP4134U10B 21.50



FP4134U15 21.50

KNOBS



KE125U10 10.75



KE125U15 10.75



KR114U10B 10.75







KR114U15 10.75

Door Hardware

Please call for the **Best Price**
(954) 825-4731

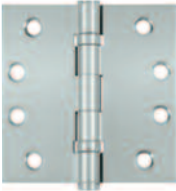
HINGES

	Item No.	Description	Box QTY	LIST
	06805	3-1/2x3-1/2 5/8-Radius Primed-Finish	100	1.10
	06795	3-1/2x3-1/2 5/8-Radius 2D-Finish	100	1.70
	US2D 06789	3-1/2x3-1/2 5/8-Radius 15-Finish	100	1.75
	06790	3-1/2x3-1/2 5/8-Radius 15A-Finish	100	2.10
	06799	3-1/2x3-1/2 5/8-Radius 5-Finish	100	2.20
	06793	3-1/2x3-1/2 5/8-Radius 26-Finish	100	5.80
	53257	3-1/2x3-1/2 5/8-Radius 10C-Finish	100	6.10
	89550	3-1/2x3-1/2 5/8-Radius Ball-Bearing 10C-Finish	100	3.20
	US10C 06801	3-1/2x3-1/2 5/8-Radius Ball-Bearing 15-Finish	100	2.75
	06802	3-1/2x3-1/2 5/8-Radius Ball-Bearing 15A-Finish	100	3.20
	24322	3-1/2x3-1/2 5/8-Radius Ball-Bearing 26-Finish	100	7.15
	24323	3-1/2x3-1/2 5/8-Radius Ball-Bearing 5-Finish	100	7.15
	96867	LH 4x4 5/8-Radius/Square Spring 15-Finish	50	10.40
	US15 96868	RH 4x4 5/8-Radius/Square Spring 15-Finish	50	10.40
	79099	LH 4x4 5/8-Radius/Square Spring Primed-Finish	50	11.60
	79100	RH 4x4 5/8-Radius/Square Spring Primed-Finish	50	11.60
	08098	LH 4x4 5/8-Radius/Square Spring 2D-Finish	50	11.90
	08099	RH 4x4 5/8-Radius/Square Spring 2D-Finish	50	11.90
	96865	LH 4x4 5/8-Radius/Square Spring 10C-Finish	50	12.40
	96866	RH 4x4 5/8-Radius/Square Spring 10C-Finish	50	12.40
	US26 96863	LH 4x4 5/8-Radius/Square Spring 5-Finish	50	12.40
	96864	RH 4x4 5/8-Radius/Square Spring 5-Finish	50	12.40
	96869	LH 4x4 5/8-Radius/Square Spring 15A-Finish	50	12.40
	96870	RH 4x4 5/8-Radius/Square Spring 15A-Finish	50	12.40
	96871	LH 4x4 5/8-Radius/Square Spring 26-Finish	50	12.40
	96872	RH 4x4 5/8-Radius/Square Spring 26-Finish	50	12.40
	Primed 08107	LH 4x4 5/8-Radius/Square Safety Stud 2D-Finish	100	1.76
	08114	RH 4x4 5/8-Radius/Square Safety Stud 2D-Finish	100	1.96
	08109	LH 4x4 5/8-Radius/Square Safety Stud Primed-	5000	2.00
	08116	RH 4x4 5/8-Radius/Square Safety Stud Primedb	5000	2.00
	08104	LH 4x4 5/8-Radius/Square Safety Stud 15A-Finish	100	2.40
	08111	RH 4x4 5/8-Radius/Square Safety Stud 15A-Finish	100	2.40

Sold In Full Carton Only.



Square



5/8-Radius



www.JELD-WENEXPORT.COM

Door Hardware

HINGES

Item No.	Description	Box QTY	LIST
08103	LH 4x4 5/8-Radius/Square Safety Stud 15-Finish	100	2.30
08110	RH 4x4 5/8-Radius/Square Safety Stud 15-Finish	100	2.30
08105	LH 4x4 5/8-Radius/Square Safety Stud 26-Finish	100	2.80
08112	RH 4x4 5/8-Radius/Square Safety Stud 26-Finish	100	2.80
27829	LH 4x4 5/8-Radius/Square Safety Stud 5-Finish	100	2.95
27830	RH 4x4 5/8-Radius/Square Safety Stud 5-Finish	100	2.95
89571	LH 4x4 5/8-Radius/Square Safety Stud 10C-Finish	100	3.15
89572	RH 4x4 5/8-Radius/Square Safety Stud 10C-Finish	100	3.15
A4150	LH 4x4 5/8-Radius/Square Safety Stud Ball-Bearing Primed-Finish	100	3.40
A4151	RH 4x4 5/8-Radius/Square Safety Stud Ball-Bearing Primed-Finish	100	3.40
96842	LH 4x4 5/8-Radius/Square Safety Stud Ball Bearing 2D-Finish	100	3.20
96843	RH 4x4 5/8-Radius/Square Safety Stud Ball Bearing 2D-Finish	100	3.20
96848	LH 4x4 5/8-Radius/Square Safety Stud Ball Bearing 10C-Finish	100	4.15
96849	RH 4x4 5/8-Radius/Square Safety Stud Ball Bearing 10C-Finish	100	4.15
96846	LH 4x4 5/8-Radius/Square Safety Stud Ball-Bearing 5-Finish	100	3.95
96847	RH 4x4 5/8-Radius/Square Safety Stud Ball-Bearing 5-Finish	100	3.95
96850	LH 4x4 5/8-Radius/Square Safety Stud Ball Bearing 15-Finish	100	3.30
96851	RH 4x4 5/8-Radius/Square Safety Stud Ball Bearing 15-Finish	100	3.30
96852	LH 4x4 5/8-Radius/Square Safety Stud Ball-Bearing 15A-Finish	100	3.95
96853	RH 4x4 5/8-Radius/Square Safety Stud Ball-Bearing 15A-Finish	100	3.95
96854	LH 4x4 5/8-Radius/Square Safety Stud Ball-Bearing 26-Finish	100	4.30
96855	RH 4x4 5/8-Radius/Square Safety Stud Ball-Bearing 26-Finish	100	4.30
96858	LH 4x4 5/8-Radius/Square Safety Stud Ball-Bearing 32D-Finish	100	20.40
96859	RH 4x4 5/8-Radius/Square Safety Stud Ball-Bearing 32D-Finish	100	20.40



Primed



US2D

Sold In Full Carton Only.

Door Hardware

HINGES

Item No.	Description	Box QTY	LIST
A9745	4x4 5/8-Radius Safety Stud Ball Bearing 2D-Finish	100	3.20
A9748	4x4 5/8-Radius Safety Stud Ball Bearing 15-Finish	100	3.30
A9752	4x4 5/8-Radius Safety Stud Ball Bearing Primed-Finish	100	3.40
A9746	4x4 5/8-Radius Safety Stud Ball Bearing 5-Finish	100	3.95
A9749	4x4 5/8-Radius Safety Stud Ball Bearing 15A-Finish	100	3.95
A9747	4x4 5/8-Radius Safety Stud Ball Bearing 10C-Finish	100	4.15
A9750	4x4 5/8-Radius Safety Stud Ball Bearing 26-Finish	100	4.30
A9751	4x4 5/8-Radius Safety Stud Ball Bearing 32D-Finish	100	20.40
A1366	LH 4x4-1/4 5/8-Radius/Square Safety Stud Ball Bearing 15-Finish	100	3.40
A1367	RH 4x4-1/4 5/8-Radius/Square Safety Stud Ball Bearing 15-Finish	100	3.40
A4288	LH 4x4-1/4 5/8-Radius/Square Safety Stud Ball Bearing 2D-Finish	100	3.40
A4289	RH 4x4-1/4 5/8-Radius/Square Safety Stud Ball Bearing 2D-Finish	100	3.40
A4286	LH 4x4-1/4 5/8-Radius/Square Safety Stud Ball-Bearing Primed-Finish	100	3.60
A4287	RH 4x4-1/4 5/8-Radius/Square Safety Stud Ball-Bearing Primed-Finish	100	3.60
A1372	LH 4x4-1/4 5/8-Radius/Square Safety Stud Ball Bearing 10C-Finish	100	3.95
A1373	RH 4x4-1/4 5/8-Radius/Square Safety Stud Ball Bearing 10C-Finish	100	3.95
A1370	LH 4x4-1/4 5/8-Radius/Square Safety Stud Ball Bearing 5-Finish	100	3.95
A1371	RH 4x4-1/4 5/8-Radius/Square Safety Stud Ball Bearing 5-Finish	100	3.95
A1374	LH 4x4-1/4 5/8-Radius/Square Safety Stud Ball Bearing 15A-Finish	100	3.95
A1375	RH 4x4-1/4 5/8-Radius/Square Safety Stud Ball Bearing 15A-Finish	100	3.95
A1376	LH 4x4-1/4 5/8-Radius/Square Safety Stud Ball Bearing 26-Finish	100	3.95
A1377	RH 4x4-1/4 5/8-Radius/Square Safety Stud Ball Bearing 26-Finish	100	3.95
B8627	LH 4x4-1/4 5/8-Radius/Square Safety Stud Ball Bearing 32D-Finish	100	22.00
B8628	RH 4x4-1/4 5/8-Radius/Square Safety Stud Ball Bearing 32D-Finish	100	22.00
A1364	LH 4x4-1/4 5/8-Radius/Square Safety Stud 15-Finish	100	2.40
A1365	RH 4x4-1/4 5/8-Radius/Square Safety Stud 15-Finish	100	2.40
A4284	LH 4x4-1/4 5/8-Radius/Square Safety Stud Primed-Finish	100	2.60
A4285	RH 4x4-1/4 5/8-Radius/Square Safety Stud Primed-Finish	100	2.60

Sold In Full Carton Only.

Door Hardware

Thresholds

ITEM#STEEL DOORS - OUTSWING SILLS

G3771 Sill - 4-9/16" NT Fixed Aluminum W/SYN Sub 1/2" Notched O/S 2/00
G3772 Sill - 4-9/16" NT Fixed Aluminum W/SYN Sub 1/2" Notched O/S 2/06
G3773 Sill - 4-9/16" NT Fixed Aluminum W/SYN Sub 1/2" Notched O/S 2/08
G3774 Sill - 4-9/16" NT Fixed Aluminum W/SYN Sub 1/2" Notched O/S 2/10
84209 Sill - 4-9/16" NT Fixed Aluminum W/SYN Sub 1/2" Notched O/S 3/00
G3775 Sill - 4-9/16" NT Fixed Aluminum W/SYN Sub 1/2" Notched O/S 5/00-1/2
G3776 Sill - 4-9/16" NT Fixed Aluminum W/SYN Sub 1/2" Notched O/S 5/04-1/2
G3777 Sill - 4-9/16" NT Fixed Aluminum W/SYN Sub 1/2" Notched O/S 6/00-1/2

G3778 Sill - 4-9/16" NT Fixed Bronze W/SYN Sub 1/2" Notched O/S 2/06
G3779 Sill - 4-9/16" NT Fixed Bronze W/SYN Sub 1/2" Notched O/S 2/08
G3781 Sill - 4-9/16" NT Fixed Bronze W/SYN Sub 1/2" Notched O/S 3/00
G3782 Sill - 4-9/16" NT Fixed Bronze W/SYN Sub 1/2" Notched O/S 5/00-1/2
G3783 Sill - 4-9/16" NT Fixed Bronze W/SYN Sub 1/2" Notched O/S 5/04-1/2
G3784 Sill - 4-9/16" NT Fixed Bronze W/SYN Sub 1/2" Notched O/S 6/00-1/2

WOOD DOORS - OUTSWING SILLS

G3785 Sill - 4-9/16" NT Fixed Aluminum W/SYN Sub 1/2" Notched O/S 2/06-3/16
G3786 Sill - 4-9/16" NT Fixed Aluminum W/SYN Sub 1/2" Notched O/S 2/08-3/16
G3787 Sill - 4-9/16" NT Fixed Aluminum W/SYN Sub 1/2" Notched O/S 3/00-3/16
G3788 Sill - 4-9/16" NT Fixed Aluminum W/SYN Sub 1/2" Notched O/S 5/01
G3789 Sill - 4-9/16" NT Fixed Aluminum W/SYN Sub 1/2" Notched O/S 5/05
G3790 Sill - 4-9/16" NT Fixed Aluminum W/SYN Sub 1/2" Notched O/S 5/09
G3791 Sill - 4-9/16" NT Fixed Aluminum W/SYN Sub 1/2" Notched O/S 6/01

G3792 Sill - 4-9/16" NT Fixed Bronze W/SYN Sub 1/2" Notched O/S 3/00-3/16
G3793 Sill - 4-9/16" NT Fixed Bronze W/SYN Sub 1/2" Notched O/S 6/01

IMPACT STEEL DOORS - OUTSWING SILLS

G3794 Sill - 4-9/16" NT Fixed Water Rated Aluminum W/SYN Sub 1/2" Notched O/S 2/00
G3795 Sill - 4-9/16" NT Fixed Water Rated Aluminum W/SYN Sub 1/2" Notched O/S 2/06
G3796 Sill - 4-9/16" NT Fixed Water Rated Aluminum W/SYN Sub 1/2" Notched O/S 2/08
G3797 Sill - 4-9/16" NT Fixed Water Rated Aluminum W/SYN Sub 1/2" Notched O/S 3/00
G3798 Sill - 4-9/16" NT Fixed Water Rated Aluminum W/SYN Sub 1/2" Notched O/S 5/00-1/2
G3799 Sill - 4-9/16" NT Fixed Water Rated Aluminum W/SYN Sub 1/2" Notched O/S 5/04-1/2
G3800 Sill - 4-9/16" NT Fixed Water Rated Aluminum W/SYN Sub 1/2" Notched O/S 6/00-1/2

G3801 Sill - 4-9/16" NT Fixed Water Rated Bronze W/SYN Sub 1/2" Notched O/S 2/08
G3802 Sill - 4-9/16" NT Fixed Water Rated Bronze W/SYN Sub 1/2" Notched O/S 3/00
G3803 Sill - 4-9/16" NT Fixed Water Rated Bronze W/SYN Sub 1/2" Notched O/S 6/00-1/2

Door Hardware

JOHNSON POCKET		
CAT. NO.	DESCRIPTION	LIST
13767	Johnson# 1500 3/0 x 6/8 Wallpocket Frame 2/0-3/0 Adjustable. Great when space is an issue.	133.25

CUSTOM FRAMES
AVAILABLE

CALL FOR AVAILABILITY

Wall Mount	
CAT. NO.	DESCRIPTION
78611	Johnson 2610F721 Wallpocket Hardware Set



BIFOLD HARDWARE for Louver Bifolds		
CAT. NO.	DESCRIPTION	Retail
16540	2/0 Track White	2.50
16541	2/6 Track White	3.75
16542	3/0 Track White	4.55
16543	4/0 Track White	6.05
16544	5/0 Track White	7.60
16545	6/0 Track White	8.30
54050	2-door bag of hardware	7.75

BIFOLD HARDWARE For Moulded & Birch Bifolds		
CAT. NO.	DESCRIPTION	Retail
16564	2/0 White Track	3.95
16566	2/6 White Track	3.95
16568	3/0 White Track	3.95
16569	4/0 White Track	4.80
16571	5/0 White Track	5.70
16572	6/0 White Track	6.60
16561	2-door bag of hardware	6.50

Door Hardware

HEAVY DUTY ARCHITECTURAL DOOR HARDWARE

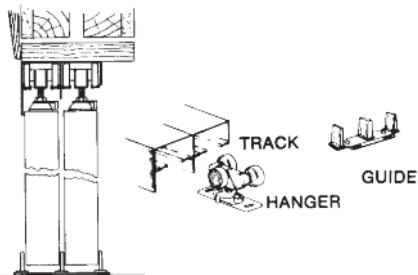

CAT. NO.	DESCRIPTION	PACK	Retail
----------	-------------	------	--------

#138F Sliding Door Hardware Heavy Duty for 1-3/8" Doors

13763	48" Track & Hardware	5	53.15
13764	60" Track & Hardware	5	59.75
13765	72" Track & Hardware	5	66.10
13766	96" Track & Hardware	5	103.55

#134 Sliding Door Hardware Heavy Duty for 1-3/4" Doors

13759	48" Track & Hardware	5	56.70
13760	60" Track & Hardware	5	64.10
13761	72" Track & Hardware	5	71.20
13762	96" Track & Hardware	5	110.65

#100 Bifold Door Hardware Heavy Duty for 2-Door Units

13740	36" Track & Hardware	5	41.40
-------	----------------------	---	-------

#100 Bifold Door Hardware Heavy Duty for 4-Door Units

13741	48" Track & Hardware	5	70.55
13742	60" Track & Hardware	5	73.25
13743	72" Track & Hardware	5	76.70
13744	96" Track & Hardware	5	84.55

72461	Johnson #2054 Multi Pull Catch Set		11.55
-------	------------------------------------	--	-------

32980	703BC Door Closer		60.00
-------	-------------------	--	-------

10178	US3 Mortise in Ball Catch/Strike Plate		8.70
-------	--	--	------

10175	US3 Set Ball Catch		1.20
-------	--------------------	--	------

10734	Strikeplate US5		1.50
-------	-----------------	--	------

84275	Strikeplate US10B		1.50
-------	-------------------	--	------

10729	Strikeplate US15A		1.50
-------	-------------------	--	------

SLIDING DOOR HARDWARE

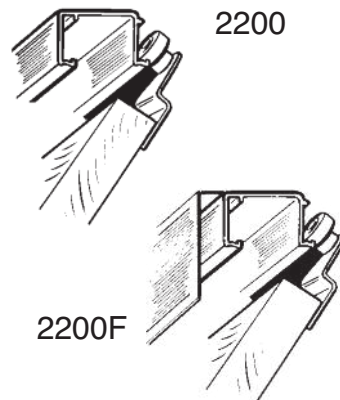

CAT. NO.	DESCRIPTION	PACK	Retail
----------	-------------	------	--------

#2200 HDWE

13824	48" Set/2 2/0 Doors	5	17.65
13825	60" Set/2 2/6 Doors	5	20.15
13826	72" Set/2 3/0 Doors	5	22.75
13827	96" Set/4 2/0 Doors	5	40.20

#2200F HDWE

13828	48" Set/2 2/0 Doors	5	26.40
13829	60" Set/2 2/6 Doors	5	30.10
13830	72" Set/2 3/0 Doors	5	33.95
13831	96" Set/4 2/0 Doors	5	56.30

#1825 BB/F HDWE

13813	3/0 2-Bifold Hdwe.	5	12.40
13814	4/0 4-Bifold Hdwe.	5	20.90
13815	5/0 4-Bifold Hdwe.	5	21.80
13816	6/0 4-Bifold Hdwe.	5	22.60
13817	8/0 4-Bifold Hdwe.	5	24.65

#1601 FOLDING DOOR HDWE.

13787	100% Access Hdwe.	5	21.80
-------	-------------------	---	-------

55499	1-3/8 Bypass Floor Guides #2138 Vinyl		2.52
-------	---------------------------------------	--	------

48768	1-3/8 Bypass Floor Guides #213500		2.52
-------	-----------------------------------	--	------

55498	1-3/4 Bypass Floor Guides #2134		2.52
-------	---------------------------------	--	------